

STABILA®

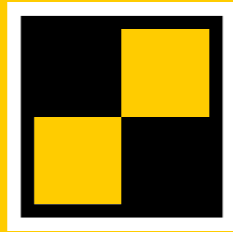

How true pro's measure

LAR 160 LAR 160 G

Operating instructions



Contents

| Section | Page |
|--|------|
| • 1. Intended use | 3 |
| • 2. Safety instructions for laser units | 3 |
| • 3. Components of the unit | 4 |
| • 4. Commissioning | 5 |
| • 4.1 Battery insertion/replacement | 5 |
| • 4.2 Switching the unit on | 5 |
| • 5. Operating mode | 6 |
| • 5.1 Automatic operation with tilt function | 6 |
| • 5.2 Automatic operation with releveling | 7 |
| • 5.3 Manual operation | 8 |
| • 6. Functions | 9 |
| • 7. LED indicators | 10 |
| • 8.1 Checking Accuracy | 11 |
| • 8.2 Horizontal check | 11 |
| • 8.3 Vertical check | 12 |
| • 9. Technical data | 13 |

1. Intended use

Congratulations on the purchase of your STABILA measuring tool. The STABILA LAR 160 / LAR 160 G is an easy-to-use rotation laser for horizontal and vertical levelling, including obtaining plumb lines. The LAR 160 / LAR 160 G has a sealed enclosure (IP 65) for use on building sites. It is self-levelling within a range of $\pm 5^\circ$.

The laser beam can be picked up using a receiver even where it can no longer be discerned with the naked eye.

LAR 160 G:

Receivers must be suitable for green laser beams.



If you still have questions after reading through the operating instructions, you can obtain advice by telephone:



+49 / 63 46 / 3 09 - 0

1.800.869.7460 U.S. and Canada

Equipment and functions:

- Laser beam
- Rotation beam
- Manual mode
- Tilt mode
- Tripod socket

2. Safety instructions for laser units



IEC 60825-1:2014



In Class 2 laser units, your eyes are usually protected from accidental, short-term exposure to the laser beam by the eyelid-closing reflex and/or the reflex reaction to turn one's head. If a laser beam hits your eye, deliberately close your eyes and move your head out of the path of the beam. Do not look into the direct or reflected beam. The STABILA laser goggles available for our laser units are not safety eyewear: their function is to improve the visibility of the laser beam.

- Do not aim the laser beam directly at people!
- Avoid dazzling other people with the unit!
- Keep the unit out of the reach of children!
- If operating or adjustment equipment that has not been specified here is used, or if the unit is not operated in the ways described here, this may result in hazardous exposure to radiation!

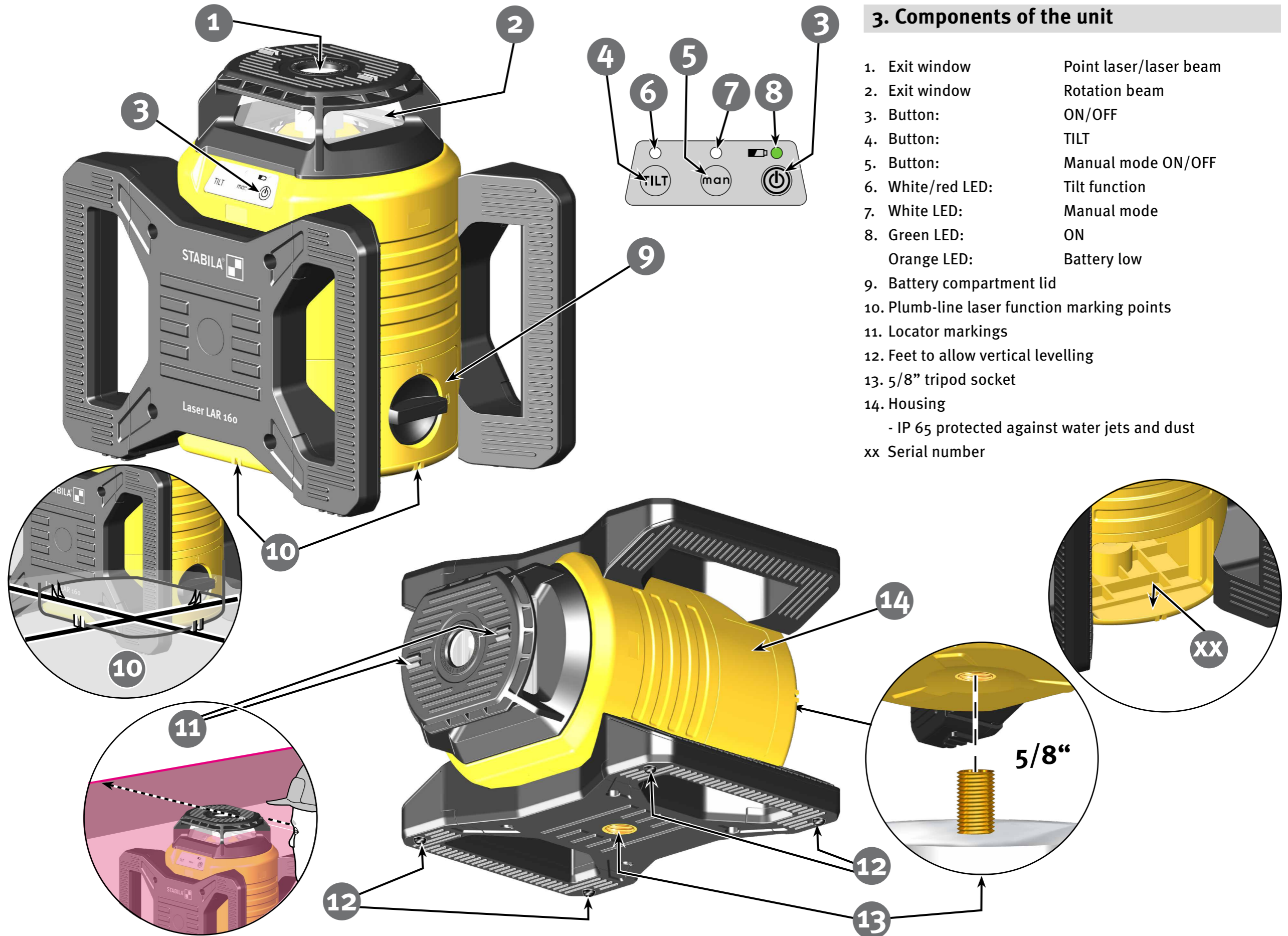

3. Components of the unit

- | | |
|--|---|
| 1. Exit window | Point laser/laser beam |
| 2. Exit window | Rotation beam |
| 3. Button: | ON/OFF |
| 4. Button: | TILT |
| 5. Button: | Manual mode ON/OFF |
| 6. White/red LED: | Tilt function |
| 7. White LED: | Manual mode |
| 8. Green LED: | ON |
| Orange LED: | Battery low |
| 9. Battery compartment lid | |
| 10. Plumb-line laser function marking points | |
| 11. Locator markings | |
| 12. Feet to allow vertical levelling | |
| 13. 5/8" tripod socket | |
| 14. Housing | |
| | - IP 65 protected against water jets and dust |
| | xx Serial number |

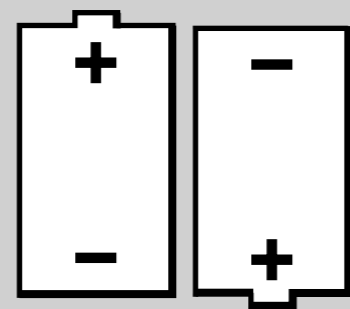
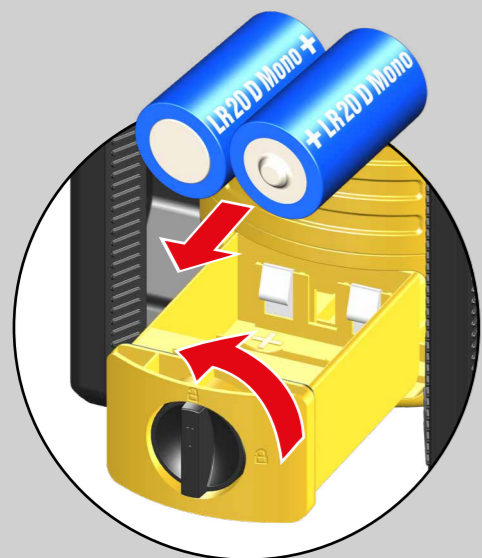

2x 1.5 V
Alkaline
D, LR20, Mono

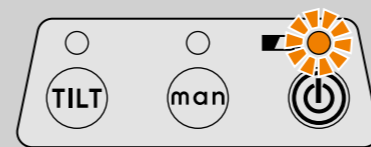
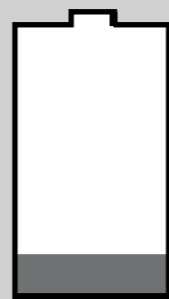

4. Commissioning

4.1 Battery insertion/replacement

Open the battery compartment lid (9) in the direction of the arrow and insert new batteries in the battery compartment as indicated by the symbol.

Suitable rechargeable batteries can also be used.

LED indicator:

Orange LED: Battery capacity low
- Insert new battery



Used batteries should be disposed of at appropriate collection points.

Do not dispose of in household waste.

If you do not intend to use the unit for an extended period, remove the batteries.

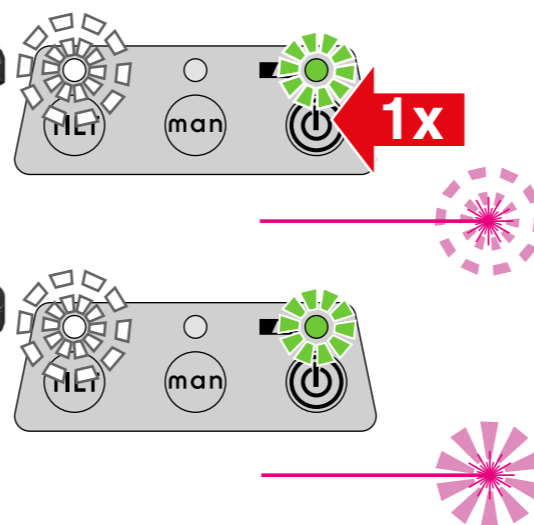
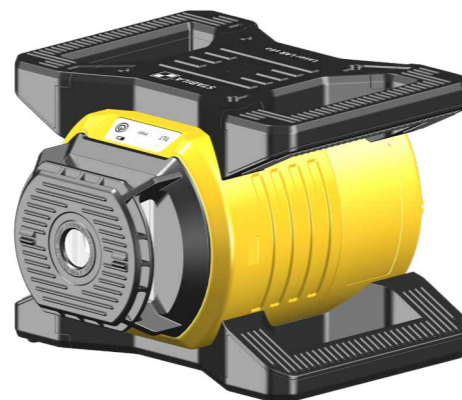

4.2 Switching the unit on

Place the laser unit in the appropriate working position (vertical or horizontal). Press the ON/OFF button to switch the laser on and off. The green LED indicates that the unit is switched on.

Activating the self-levelling function causes the unit to level itself automatically. The laser beam does not (yet) flash or rotate. Once levelling is complete, the beam stays on constantly and begins to rotate.

Fine adjustments can still be made within the first 30 seconds. These 30 seconds are indicated by a slow flashing of the white "TILT" LED.

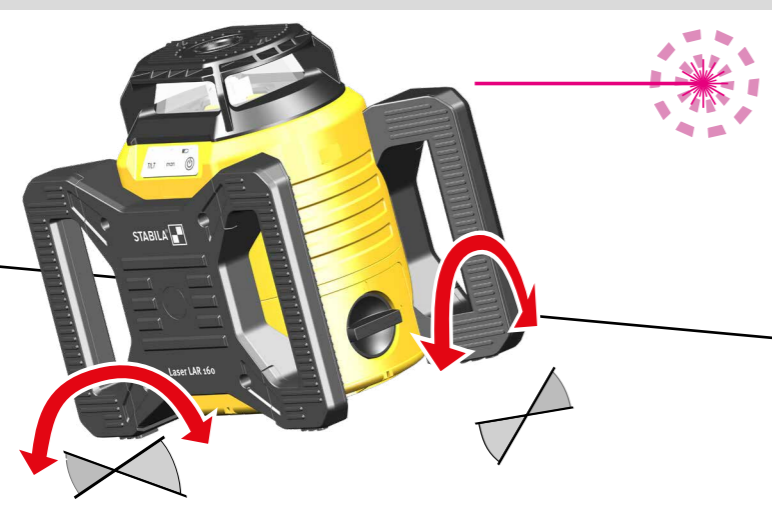

The laser lines flash if the laser unit is at too steep an angle. The laser unit is outside the self-levelling range and cannot level itself automatically.

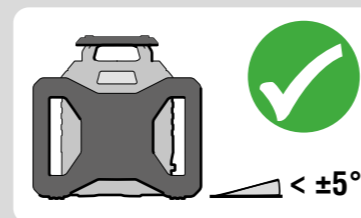

5. Operating mode

5.1 Automatic operation with tilt function

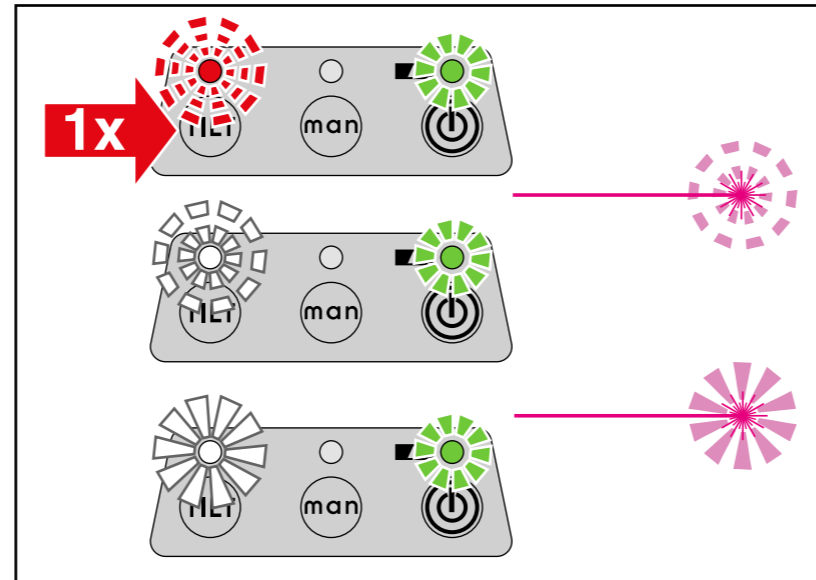
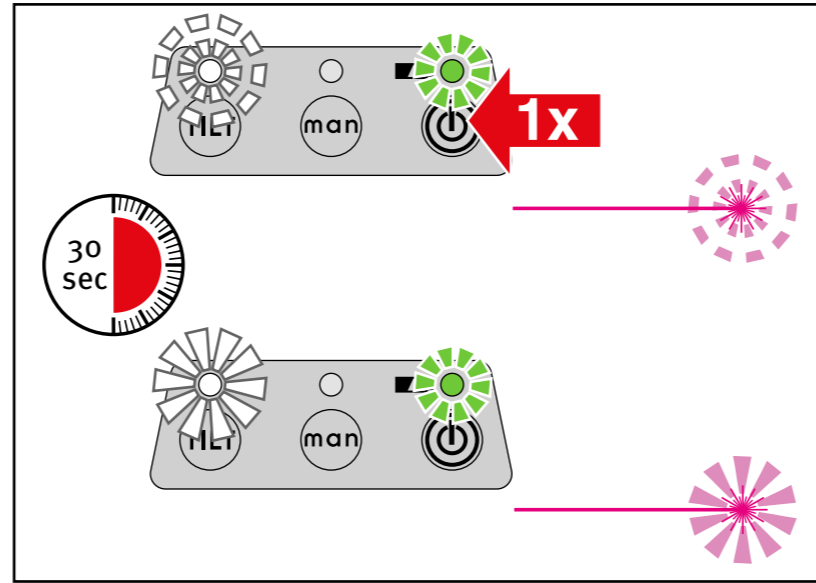
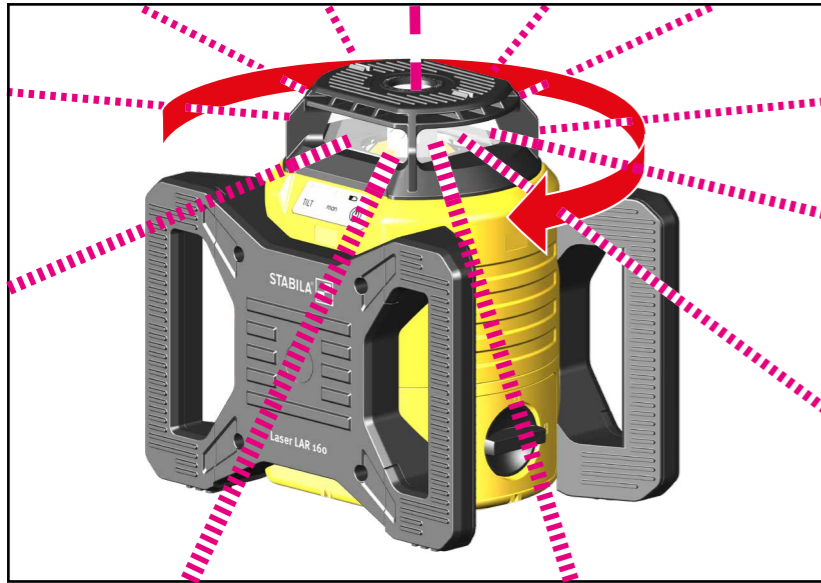

The tilt function warns if any interference to the laser has occurred that may cause misalignment. This ensures that such interference does not go unnoticed. This mode is always set directly after the unit is switched on. In “Automatic” operation, the laser unit levels itself automatically.

Place the laser unit in the appropriate working position (vertical or horizontal). Press the button (ON/OFF) once. The LAR 160 / LAR 160 G is now in “Automatic operation with tilt function”.

The automatic levelling process begins. Once levelling is complete, the beam stays on constantly and begins to rotate. Fine adjustments can still be made within the first 30 seconds. These 30 seconds are indicated by a slow flashing of the white “TILT” LED.

After 30 seconds, the white “TILT” LED lights up steadily, meaning the tilt function is active. If any event occurs that could result in the laser unit being deflected from its exact alignment and setting, the beam ceases to rotate. The “TILT” LED flashes red. If this occurs, check the laser unit and set it up once again if necessary.

You must press the “TILT” button to confirm the tilt function. Only after this can you proceed further.

If you are working in conditions where interference is present (e.g. on vibrating surfaces), it is recommended that you select “Automatic operation with releveling”.

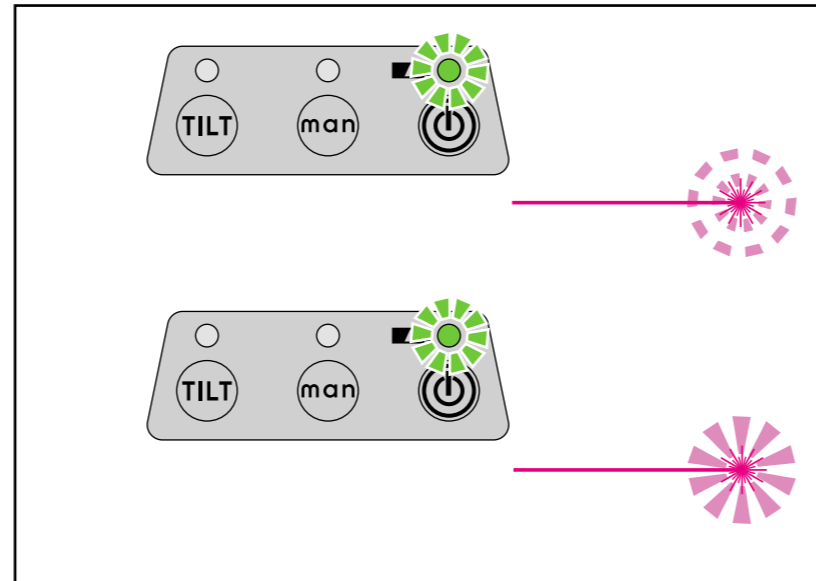
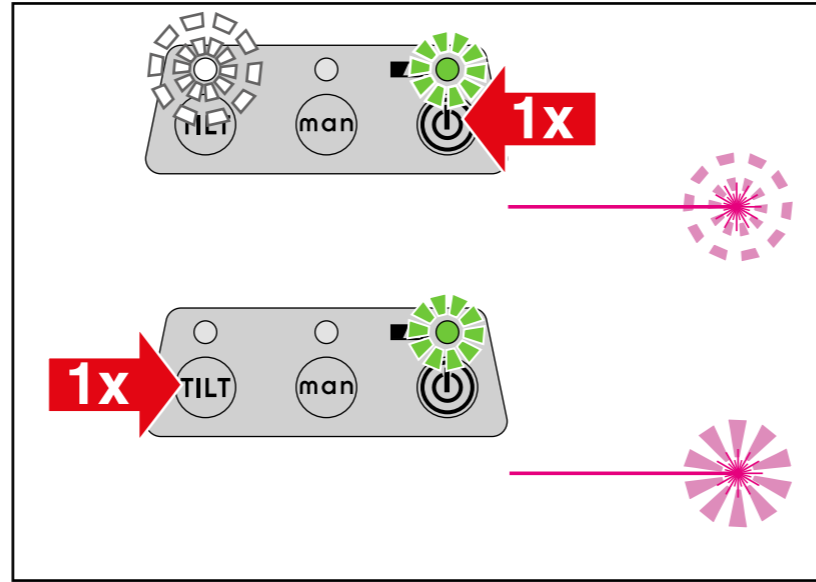
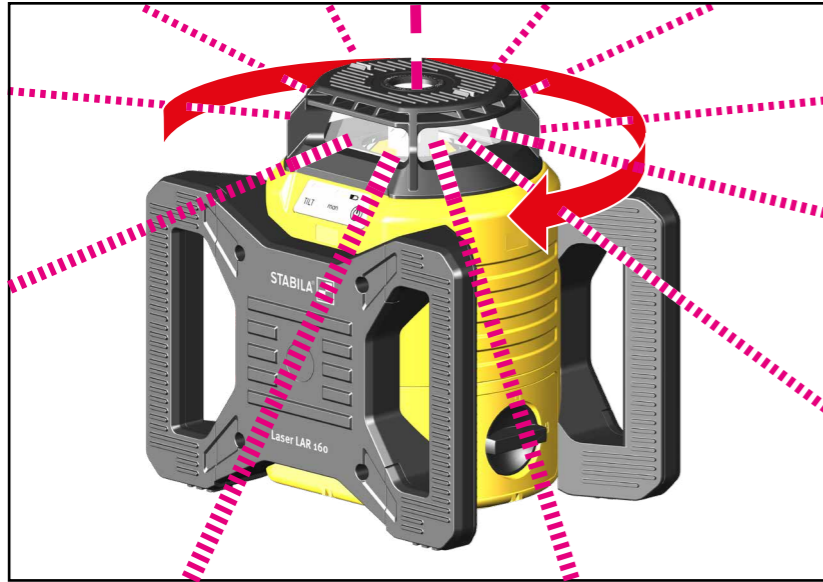

5.2 Automatic operation with releveling

In some working conditions (where shocks or vibrations affecting the surface occur, for example), the tilt function is disruptive. With automatic releveling, on the other hand, the unit is readjusted each time it is knocked out of alignment.

Place the laser unit in the appropriate working position (vertical or horizontal). Press the button (ON/OFF) once. Then press the “TILT” button to deactivate the tilt function. The green LED indicates that the unit is switched on and the laser beam flashes. Once levelling is complete, the beam stays on constantly and begins to rotate.

When incidents occur that cause misalignment, the laser beam ceases to rotate. The laser beam flashes. Now the laser unit relevels itself. Once levelling is completed, the laser beam begins to rotate once more.

If the unit is inclined at an angle $\geq 5^\circ$, it is outside the self-levelling range and cannot level itself automatically. Any deviations from the original alignment/setting of the unit are not indicated (-> Tilt function).

Pressing the “TILT” button again reactivates the tilt function.

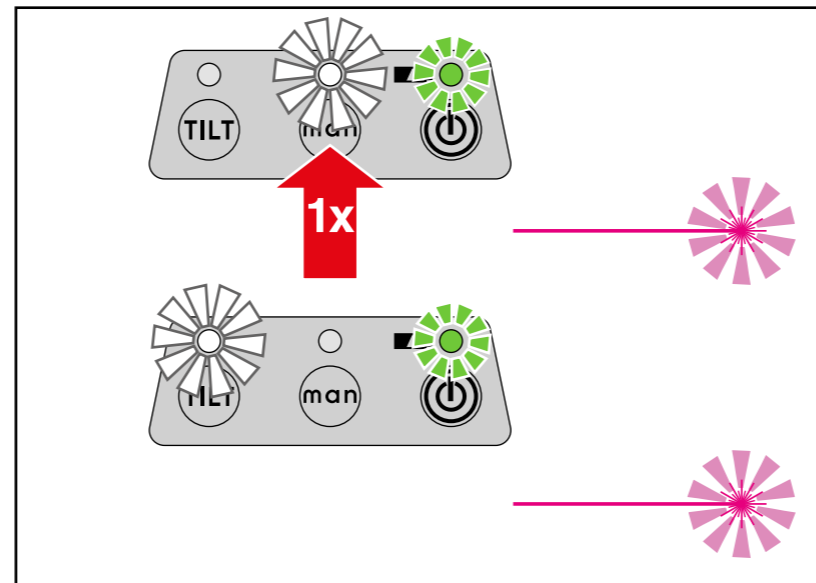
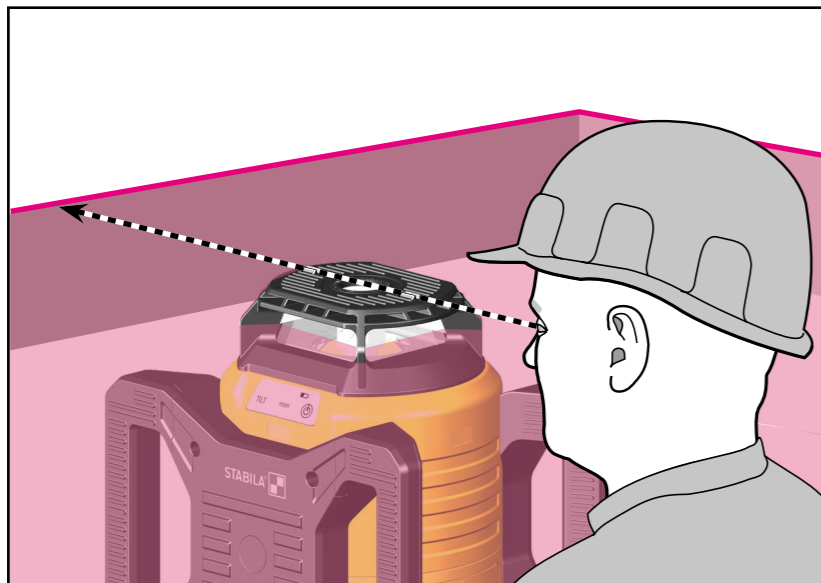
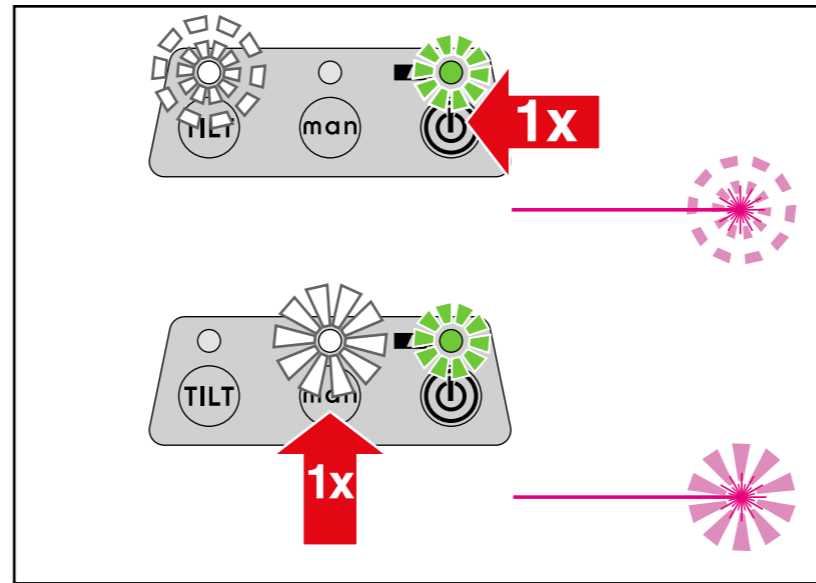

5.3 Manual operation

In manual operation, neither the tilt function nor releveling are active. In this mode the unit is aligned entirely by hand. The unit does not level itself.

Place the laser unit in the appropriate working position (vertical or horizontal). Press the “ON/OFF” button once. The green LED indicates that the unit is switched on and the laser beam flashes. The white “TILT” LED flashes. Press the “man” button to deactivate the tilt function and automatic releveling. The white “man” LED lights up steadily. The laser beam rotates.

The laser plane can be set up by direction-finding or by taking measurements. The inclinometer (available as an accessory) can be used to aid setting up the inclination.

Pressing the “man” button again deactivates manual operation. The unit reverts to mode 6.1 “Automatic operation with tilt function”.

6. Functions

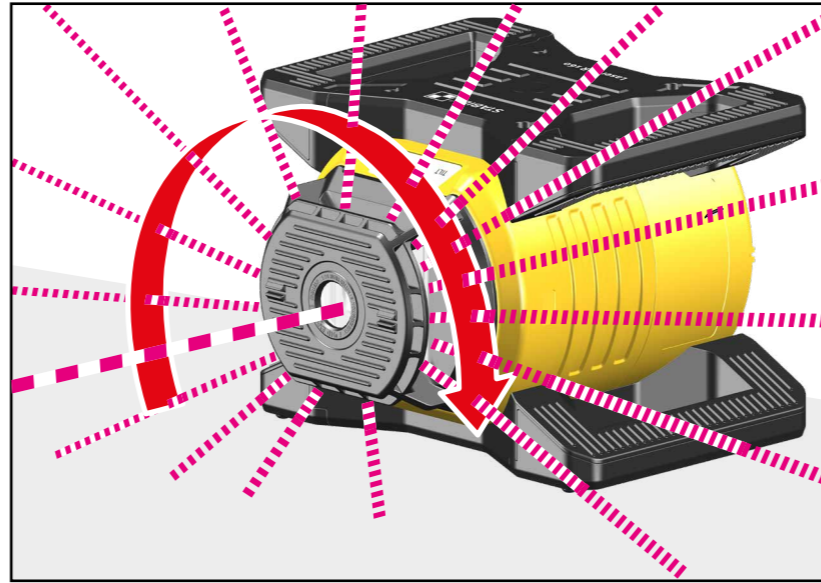
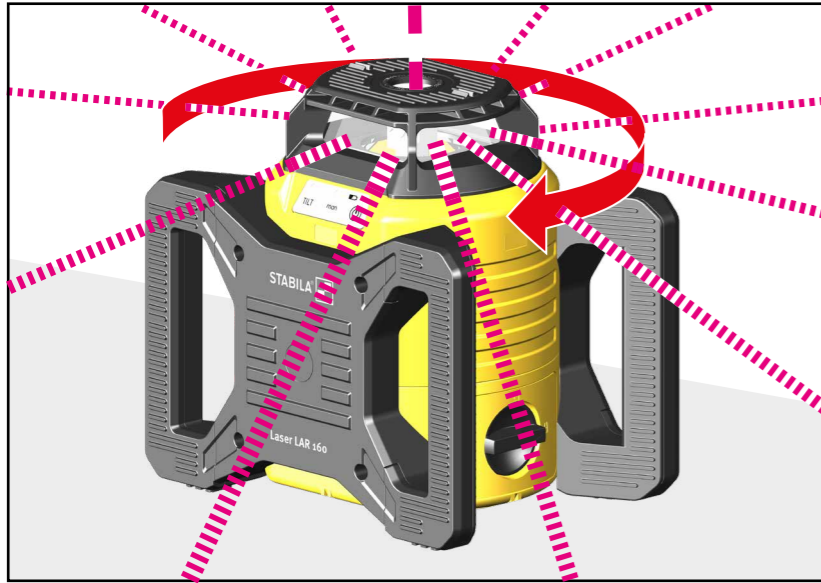

Rotation function

The laser beam rotates through 360° around its axis:

- Horizontal
- Vertical

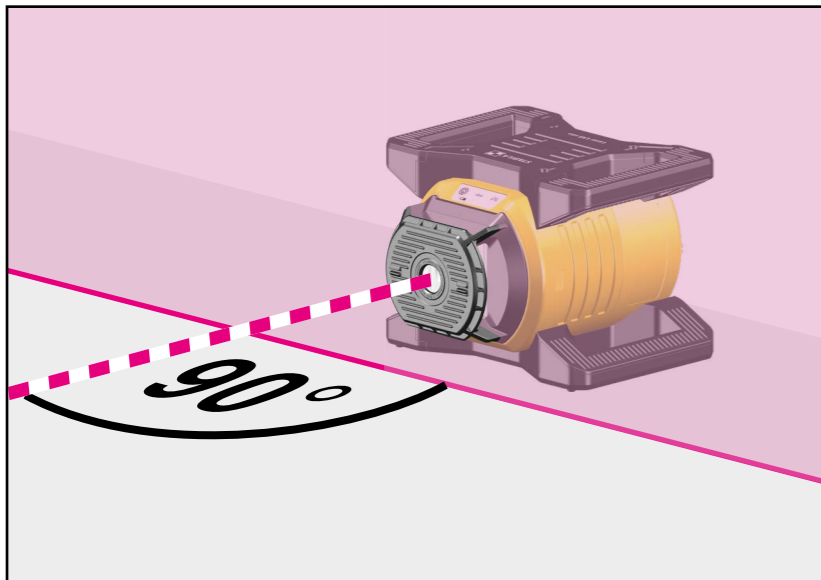
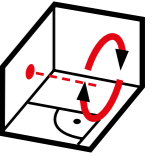
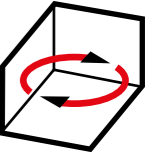

Right angle (90°)

In vertical operation, the point laser and the rotation plane form a 90° angle. This allows right angles to be created.

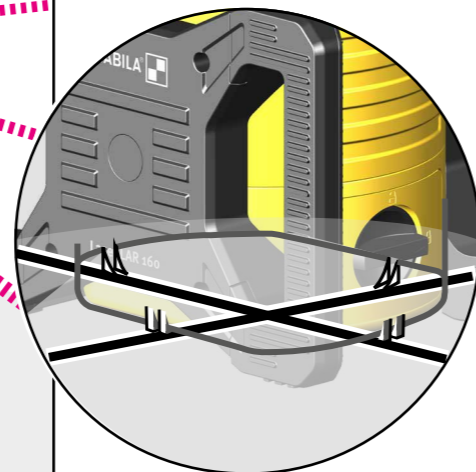
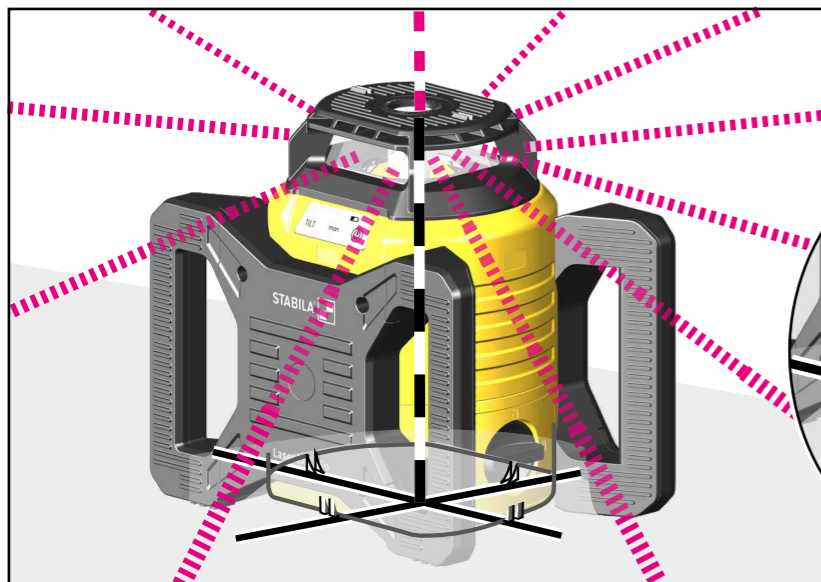

Plumb-line function

Transfers a determined point from the floor to the ceiling. To transfer a plumb line from a floor marking to the ceiling, the laser unit is aligned exactly with the cross mark with the 4 marking points (10). The point of intersection of the cross mark corresponds to the exiting laser plumb line. In automatic mode a correct result can only be obtained if the floor surface is level.

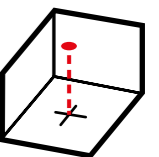

7. LED indicators

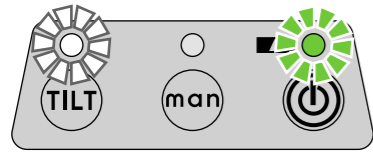

Operation with tilt function --> "Tilt function"

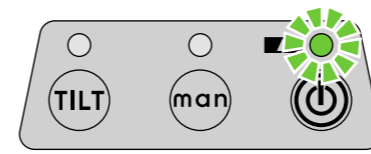
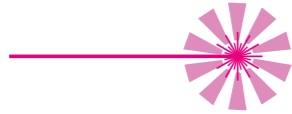

Operation without tilt function --> "Automatic operation with releveling"

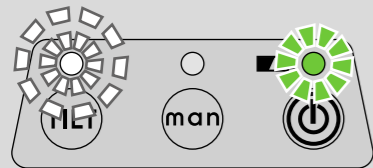

Unit levels itself

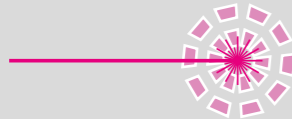

Relevelling after interference --> "Automatic operation with releveling"

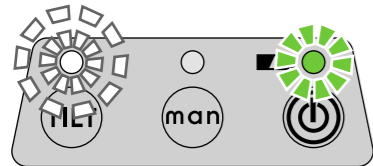
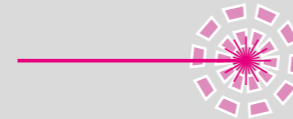

Operation with tilt function 30 seconds of fine adjustment --> "Commissioning", "Tilt function"

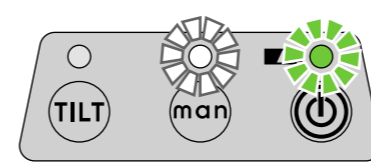
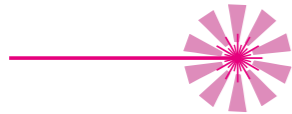

Operating in manual mode --> "Manual operation"

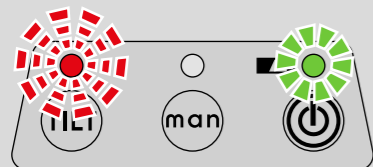

Tilt function initiated --> "Automatic operation with tilt function"

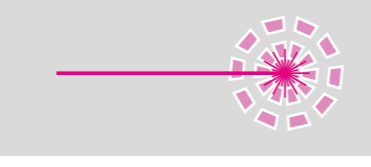

Unit is outside self-levelling range --> "Commissioning"

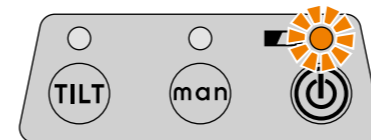
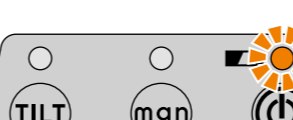

Battery capacity low --> "Battery insertion/replacement"



LED / laser beam lights up steadily



LED / laser beam flashes



LED flashes quickly

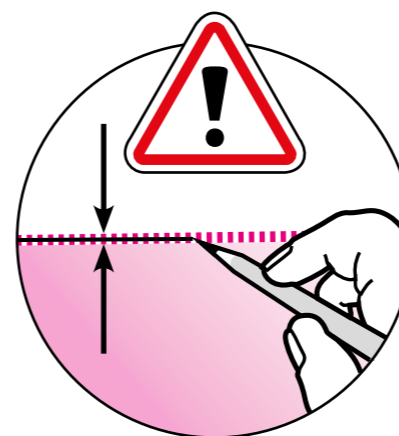
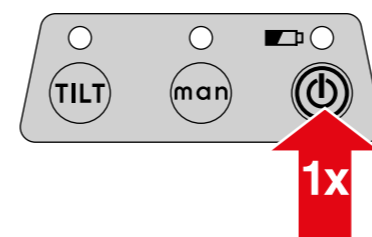
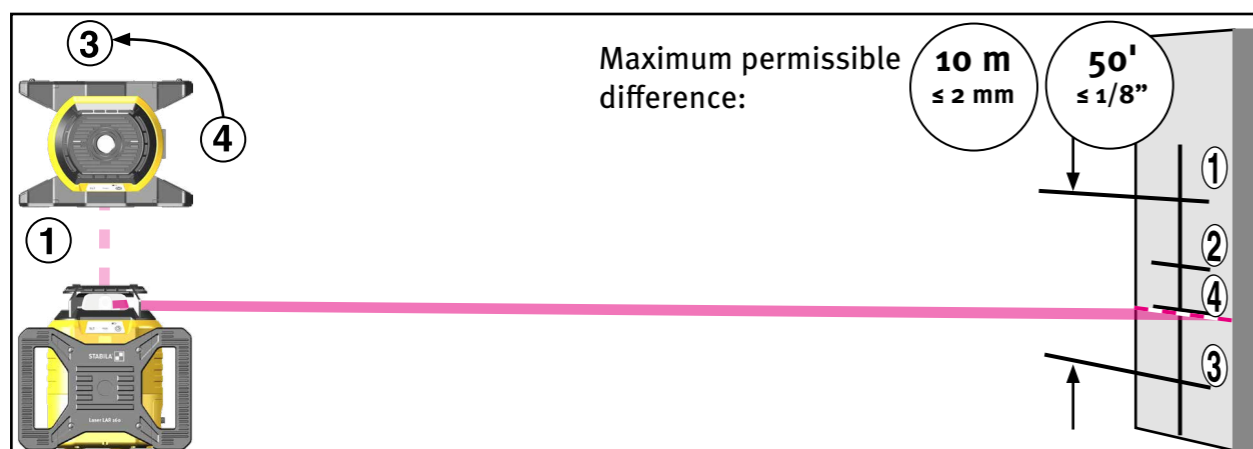
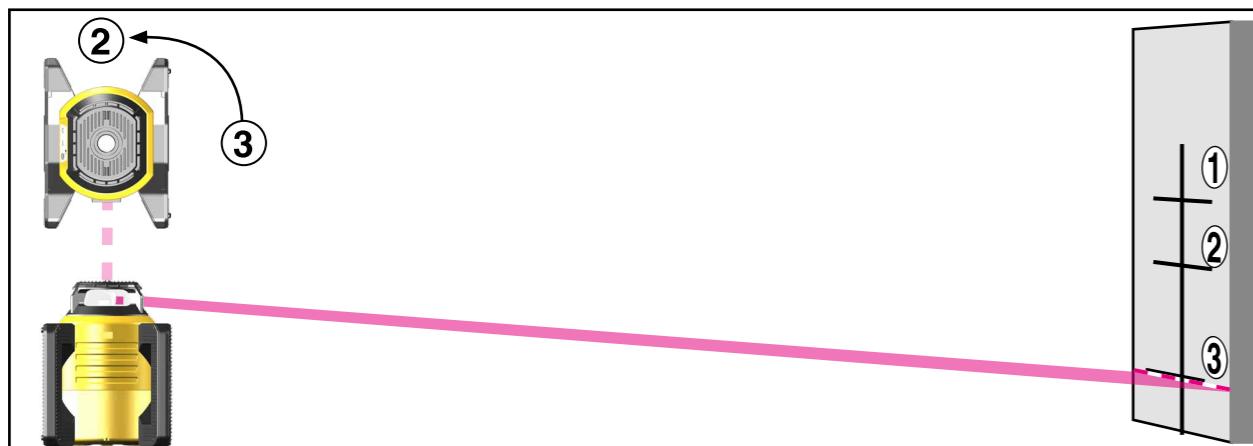
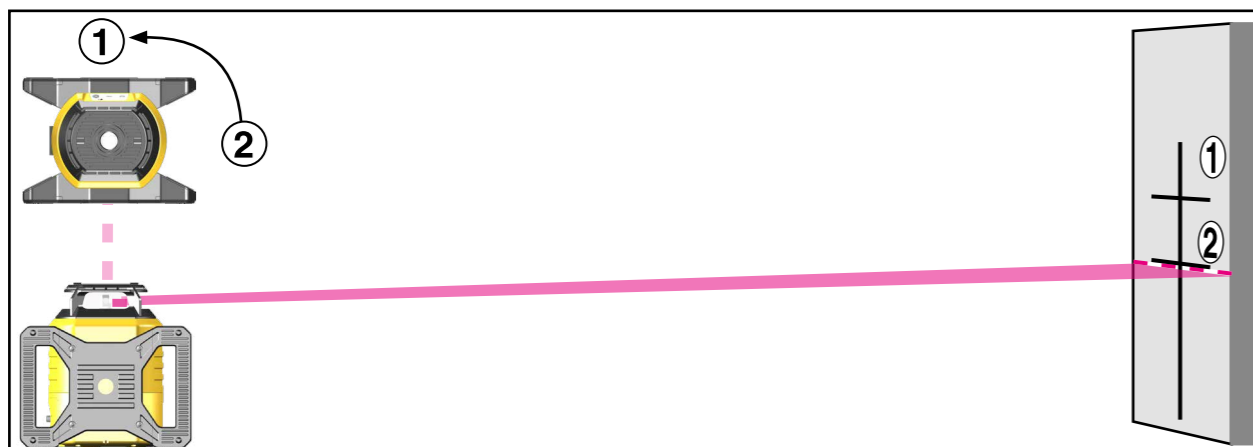
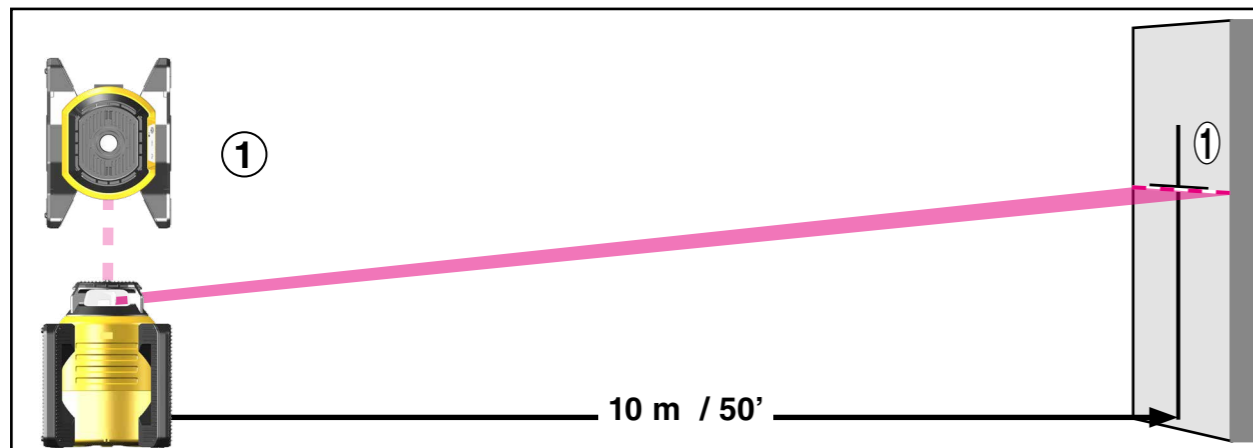

8.1 Checking Accuracy

The STABILA LAR 160/ LAR 160 G rotation laser has been designed for construction sites and has left our factory in a correctly adjusted condition. As with all precision instruments, you should regularly check the calibration accuracy of the unit. Before starting work each day, and particularly if the unit has been exposed to heavy shocks or vibrations, a check of the calibration should be carried out.

Horizontal check
Vertical check

8.2 Horizontal check

Checking the horizontal laser line level

Be sure to adhere as closely as possible to the orientation of the unit as shown.

1. Place the LAR 160 / LAR 160 G on a horizontal surface or on a tripod at a distance of at least 10 m (50') from a wall, with the operator panel towards the wall.
2. Switch the laser unit on and wait until it has automatically levelled itself.
3. Mark the centre of the visible laser line on the wall – measurement 1 (point 1). A receiver can also be used.
4. Rotate the entire laser unit through 90° without altering the height of the laser (i.e. do not change the tripod height). Allow the unit to level itself again.
5. Mark the centre of the laser line on the wall (point 2).
6. Repeat steps 4 and 5 twice to obtain points 3 and 4.
7. If the differences between the four control points are less than 2 mm (1/8") for a distance of 10 m (50'), the unit is within its permitted tolerance of ± 0.1 mm/m (± 18" over 100ft). Here points 1 and 3 correspond to the unit's x-axis and points 2 and 4 to its y-axis.

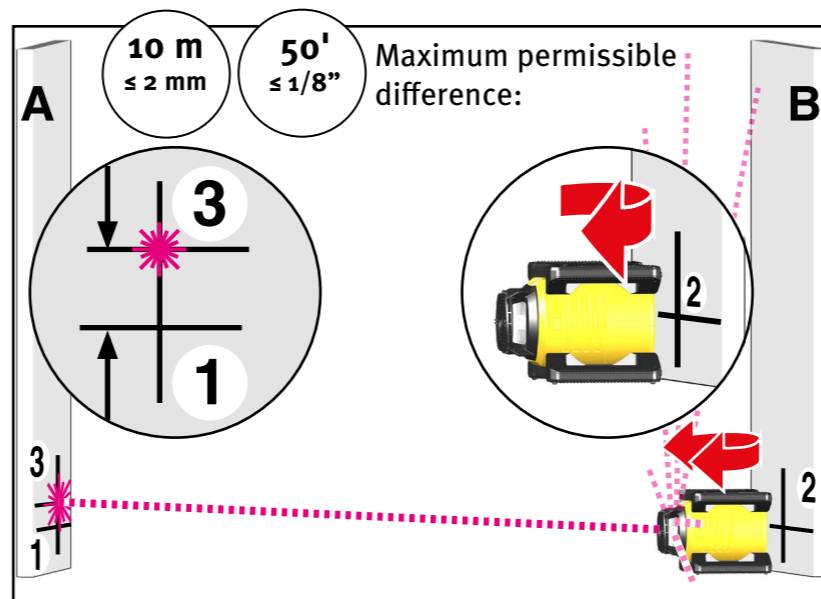
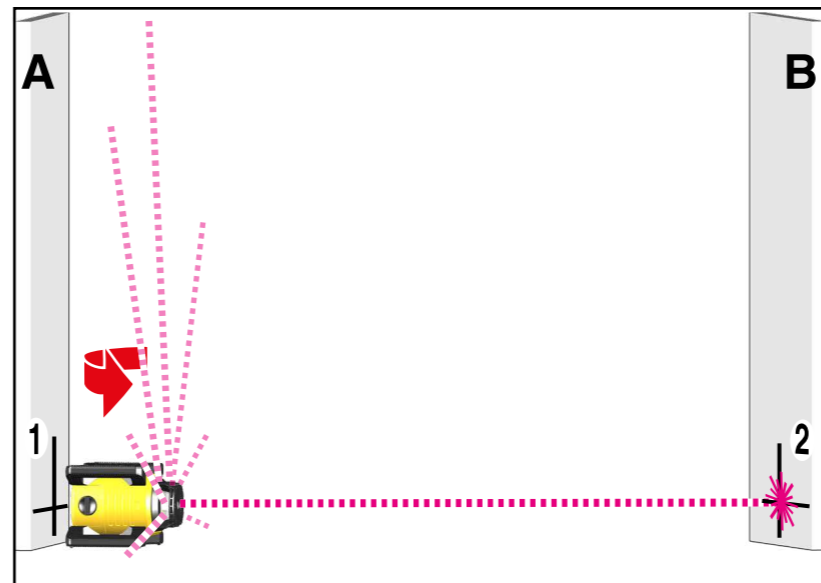
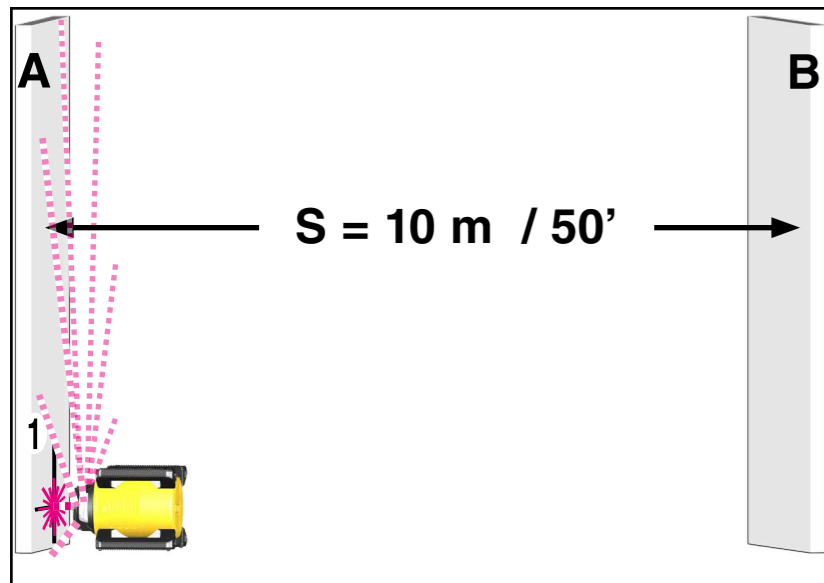

8.3 Vertical check

Checking the vertical plumb-line laser

To perform the vertical check, two parallel wall surfaces are required with a separation S of at least 10 metres.

1. Position the rotation laser directly in front of one of the walls, A, on its side-mounted feet as for vertical levelling. The LAR 160 / LAR 160 G can also be mounted on a tripod.
2. Switch on the laser unit.
3. Once automatic levelling is complete, mark the position of the laser point on wall A. Point 1.
4. Rotate the LAR 160 / LAR 160 G through 180° and align with wall B using the plumb-line laser. Do not adjust the height.
5. Once automatic levelling is complete, mark the position of the plumb-line laser point on wall B. Point 2.
6. Now reposition the laser unit so that it is directly in front of wall B. Align the LAR 160 / LAR 160 G with wall B using the plumb-line laser.
7. Once automatic levelling is complete, rotate the plumb-line laser point and move it vertically until it exactly covers point 2.
8. Rotate the LAR 160 / LAR 160 G through 180° and align with wall A using the plumb-line laser. Do not adjust the height.
9. Rotate the plumb-line laser point until it covers the marking line of point 1 exactly.
10. Once automatic levelling is complete, mark the position of the plumb-line laser point on wall A. Point 3.
11. Measure the vertical distance between points 1 and 3.

Where the distance between walls A and B is 10 m (50'), the distance between points 1 and 3 must not be greater than 2 mm (1/8").

$$0.1 \frac{\text{mm}}{\text{m}} \geq \frac{\overline{P_1 P_3}}{2S}$$

$$1/8'' \text{ over } 100\text{ft} \text{ or } 1/816 \frac{\text{inch}}{\text{ft}}$$

9. Technical data

Laser type: LAR 160 Red diode laser, wavelength 635 nm
LAR 160 G Green diode laser, wavelength 510–530 nm

Power output: < 1 mW, laser class 2 in accordance with IEC 60825-1:2014
This product compl. with the appl. requ. of 21CFR, parts 1040.10 and 1040.11.

Self-levelling range: approx. $\pm 5^\circ$

Levelling accuracy*: ± 0.1 mm/m / $\pm 1/8''$ over 50 ft

Batteries: 2 x 1.5 V alkaline, size mono, D, LR20

Battery life:

LAR 160 approx. 40 hours (alkaline)

LAR 160 G approx. 20 hours (alkaline)

Operating temperature range: -10°C to $+50^\circ\text{C}$ / 14°F to $+122^\circ\text{F}$

Storage temperature range: -25°C to $+70^\circ\text{C}$ / -13°F to $+158^\circ\text{F}$

Subject to technical modifications.

* when operated within the specified operating temperature range

2019

Europe
Central and South America
Australia
Asia
Africa



STABILA Messgeräte
Gustav Ullrich GmbH

P.O. Box 13 40 / D-76851 Annweiler
Landauer Str. 45 / D-76855 Annweiler

☎ + 49 63 46 309 - 0
✉ info@de.stabila.com

USA
Canada

STABILA Inc.

332 Industrial Drive
South Elgin, IL 60177, USA

☎ 800-869-7460
✉ custservice@Stabila.com